

SOLO

... an “invisible” electronic lock with multiple usages...

STAND-ALONE ELECTRONIC RFID LOCK FOR:

Shops and Retail:

Glass cabinets and display cases, supply cupboards, staff lockers

Hospitals:

Storage cabinets, cupboards and lockers for medical equipment or private belongings

Offices:

Filing cabinets, kitchen and stationery cupboards

Schools:

Staff and student lockers, equipment and storage cupboards

Clubs:

Staff and visitor lockers, glass display cabinets, equipment and storage cupboards



QUALITY

SOLO strives to provide customers with high-quality products. Excellent customer service as well as fast lead times and excellent customer service.

The manufacturer of Solo became ISO 9001:2008 certified on Sept. 15th, 2015.

5 YEAR WARRANTY

SOLO products are built to the highest standard in Europe using mainly European components due to this quality and assurance SOLO can offer a 5 Year Warranty.

With this 5-year warranty, products will be repaired or replaced free of charge.

The SOLO 5-year warranty covers the repair or replacement of the product once returned to the manufacturer. This excludes 3rd party damage and transportation costs.



APPLICATIONS



APPLICATIONS

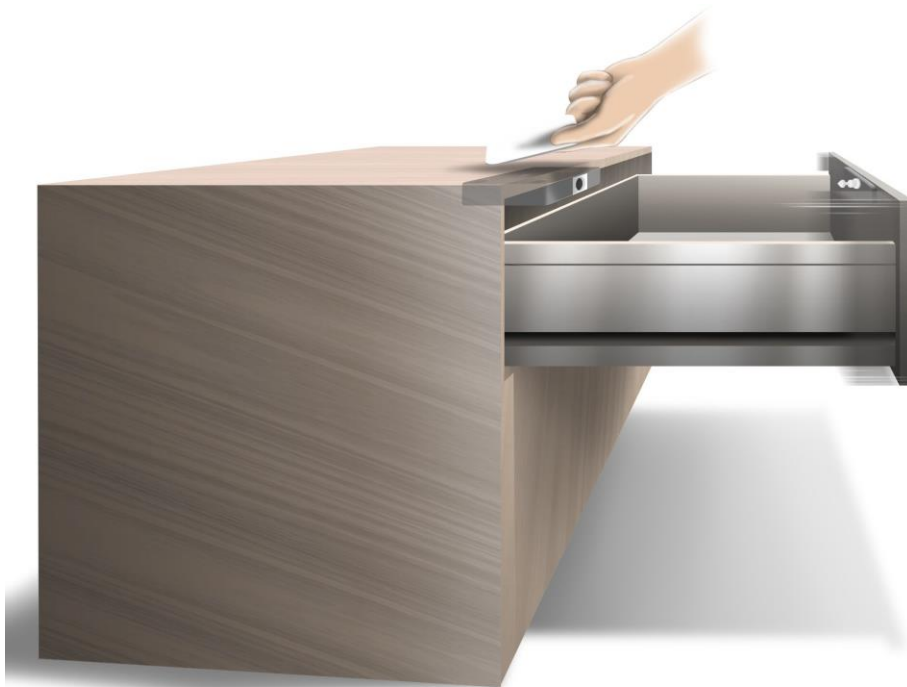

APPLICATIONS

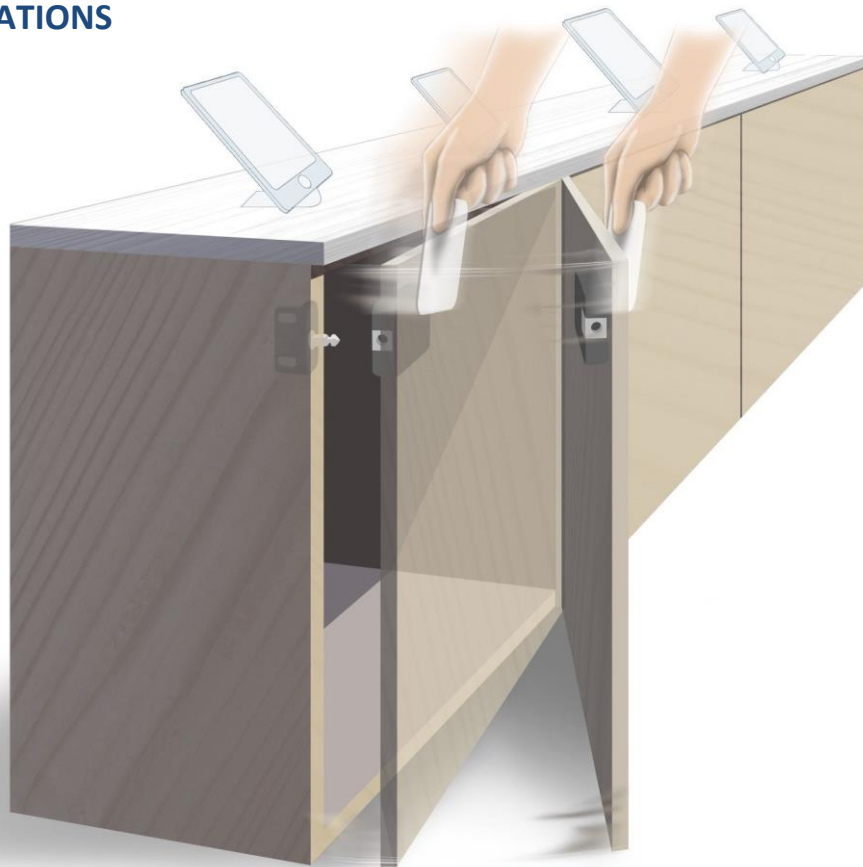

APPLICATIONS

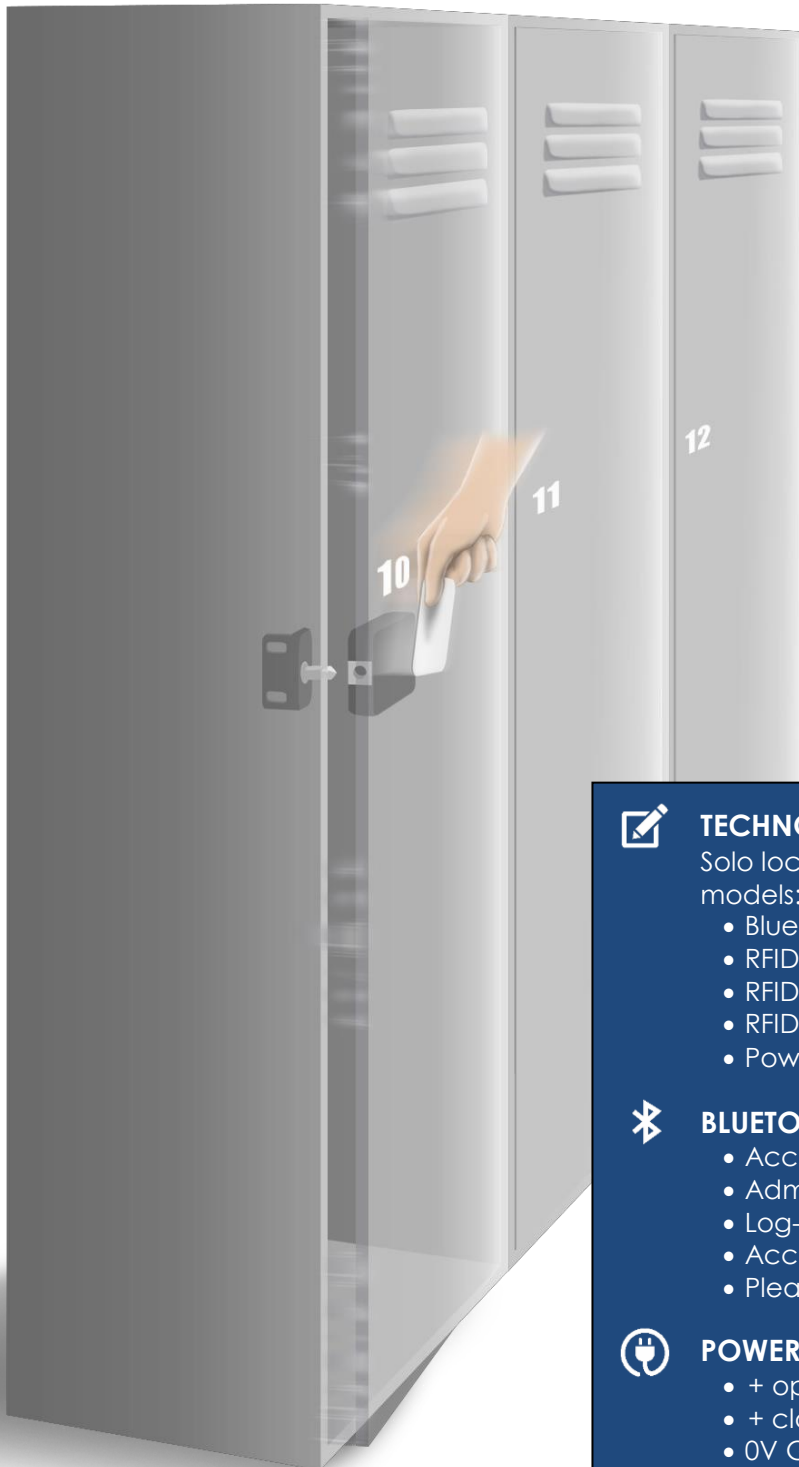

TECHNOLOGY

Solo locks are available in the following different models:

- Bluetooth
- RFID 125 kHz: Em4102/Em4200
- RFID 125 kHz: Em4450/Hitag
- RFID 13,56 mHz: all Mifare chiSolo
- Power 3V / 12V open/close



BLUETOOTH – ADMINISTRATION

- Access control via App
- Administration via App
- Log-file via App
- Access control via user grouSolo
- Please follow the instructions at the app



POWER 3V / 12V INSTRUCTIONS

- + open (brown wire)
- + close (black wire)
- 0V GND (blue)
- Default cable: 1,5 m
- Customized cable length with plugs possible
- Metal casing on request
- With / without: door closer switcher



RFID OPTIONAL FEATURES

- Door open alarm
- GYM – free locker mode
- Close manually/automatically – bolt

RFID programming instructions

1 Activating the programming card

Initializing / activating a programming card:

1. Press the push-button on the rear side.
2. The lock will make a ticking sound (signal). Hold the programming card on the lock within 3 seconds of hearing this signal.
3. Two short ascending tones will confirm that the programming card has been saved successfully.

2 Initializing a key

Initializing the key card or chip key:

1. Please place the programming card onto the lock.
2. The lock will make a ticking sound (signal). Place the key card or chip key onto the lock within 3 seconds of hearing this signal.
3. Two short ascending tones will confirm that initialization was successful.
4. The lock can now be opened using the key card or the chip key.

3 Deleting the key card or chip key

1. Please place the programming card onto the lock.
2. The lock will make a ticking sound (signal). Place the key card or chip key onto the lock within 3 seconds of hearing this signal.
3. Two short ascending tones will confirm that deletion was successful.

4 Delete all keys

To delete all keys at once, place the programming card onto the lock for several seconds.

ACCESSORIES

3050 - Battery

The 3 volt lithium battery has life-span of 10 years with the 125 KHz and 3 years with the 13,56 MHz technology. The battery has enough power to open the lock more than 30,000 times. When the battery starts to run out, the lock will no longer lock and a continuous tone will sound for 15 seconds, at this point change the battery.

Metal kit

With a stamp in the metal door, the internal antenna of the SOLO and S0L013 lock will work through the metal door.

3060 glass set

This set is similar to the metal kit and consists of an additional adhesive glue tape. Depending on where the force is applied, the double-sided sticky tape on an untreated surface will hold up to 25 kg or 45 kg (551 bs or 991 bs), depending on the direction of pull.

3051s - External power supply

The cable is 1,5 m long and can be plugged directly into the lock. Each converter can supply a maximum of 5 locks. Please note: Never use transformers and batteries at the same time!

3053s - Spacer plate

A square shaped spacer plate to prevent cables from being crushed. Measurements: 60 x 60 x 5 mm



ACCESSORIES

3040s - external antenna (125 KHz)

The flat external antenna is used whenever the distance from the key is greater than 25 mm or if the lock is fixed onto a rear panel. Cable: 1,5m



3041 - round mini antenna (125 KHz)

With a hole of 7,5mm diameter, this round mini antenna can be placed in several variations.

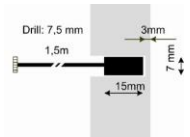

3010 - Programming card

This card can be used to give or deny access as well as to change the software settings. The same programming card can be assigned to multiple locks within a shop / area for example.



3030 - Key card

The range is approx. 30 mm cross wood or glass. Program up to 50 different keys per lock.

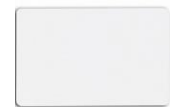

3020 - Chip key

This chip key is extremely small with a diameter of approx. 30 mm. It can be easily attached to a key ring. The maximum range is 20 mm.



Installation with the latch 3071

Equipped with a mounting bracket and a spring, this latch gives a maximum comfort during assembly based on the 3D adjustable fixing.

The mounting tolerances are within 6 mm, and the spring is used as a pusher for a door.

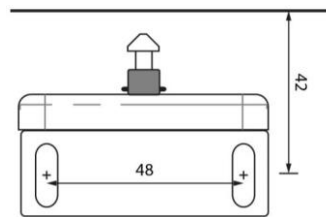
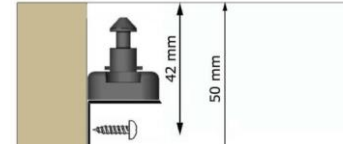
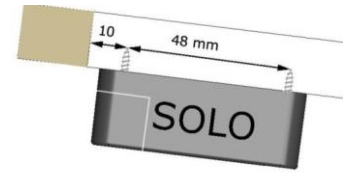
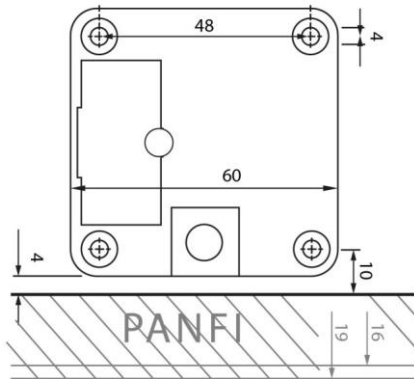

3068z - Sliding doors

This black metal locking device has a predetermined breaking point of 35 kg. The flexible pin allows a tolerance of +/- 3 mm.

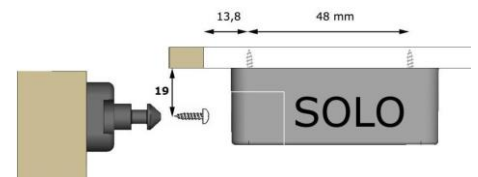

3070 - mini locking device for electronic locks

Features:

- Small measurements and nice design
- Easy to install
- Screw provided
- No predetermined breaking point
- Tolerance +/- 1,0 mm
- 12,5 mm diameter



Installation with the latch 3069

This locking device is made of ZAMAK, a robust zinc aluminium alloy and the predetermined breaking point is 35 kg.

The integrated pusher will automatically open light drawers and cabinet doors. The flexible pin allows a tolerance of +/- 1 mm.

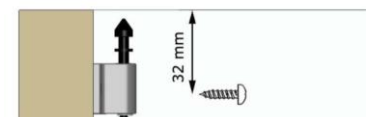
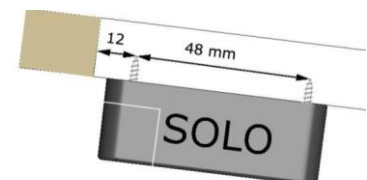



TROUBLESHOOTING

Lock is open and the keys are not working:

- The battery low alarm was activated.
- Please insert a new battery.

Key is not working:

- Is there any sound? If so, please try to activate the key with the programming card.
- No sound: Try to find the right position at the furniture. The keys have a higher range if you place them fast at the right point than moving slowly.

I lost my key:

- Delete all keys with the programming card.
- Activate all keys again.

The programming card does not work:

- Do you have a second card?
- If not, please unscrew the locks, press the button on the backside and teach the lock the programming card again.

Motor runs, lock stays locked:

- Maybe there is some pressure on the bolt in the lock.
- Move the door in all possible directions and try it again.
- Press the door in and use your key again.
- Adjust the locking devices after such a problem.

No sound with any card:

- Use a flat iron part (not a screwdriver) and break up the furniture. The rated breaking point at the latch will save the furniture.



SECURITY ADVICE



Fixing the locks

Tighten with care and manually. Please avoid using any strong electrical power.

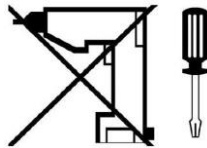

Distance in battery mode

To avoid disturbances between the locks, please keep a minimum distance of 10 cm.



< 10 cm >



Store

Whenever you prepare locks in advance, please remove the battery immediately. Insert the battery again when you have the minimum distance.



Disposal

All waste electrical and electronic equipment must be collected separately from general rubbish to be reused or recycled.

